



Video at Light Speed™

INSTRUCTION MANUAL
AES-2200 and AES-2200

Digital Audio and Data
Fiber Optic Link
Modular Card & Stand-alone

Version: 3/31/2009 6:30 PM

MultiDyne Video & Fiber Systems

MULTIDYNE, AES2200, AES2000 the Multidyne Logo and “Video at Light Speed” are registered trademarks of MULTIDYNE Electronics, Inc.

Copyright 2008 MULTIDYNE Electronics, Inc., Locust Valley, New York. Printed in the United States of America. All Rights Reserved. Contents of this publication may not be reproduced in any form without the written permission of MULTIDYNE Electronics, Inc.

This product was designed and manufactured in the
UNITED STATES of AMERICA

TABLE OF CONTENTS

INTRODUCTION	4
FEATURES	4
OPERATION	4
AUDIO AND DATA TRANSPORT	4
STATUS INDICATORS AND ALARMS	4
DATA TRANSPORT SETUP	4
SPECIFICATIONS	5
DRAWINGS	5
AES-2200-FTX MODUAR CARD MECHANICAL DRAWING	6
AES-2200-FRX MODUAR CARD MECHANICAL DRAWING	7
AES-2200 MODULAR CARD WIRING PINOUT	8
AES-2000-FTX STAND-ALONE MECHANICAL DRAWING	9
AES-2000-FRX STAND-ALONE MECHANICAL DRAWING	10
AES-2000 STAND-ALONE PORTABLE PINOUT	11
AES-2000 STAND-ALONE INTERFACE ADAPTER PINOUT	12

INTRODUCTION

The Multidyne **AES-2200** is an 8 channel AES3/SPDIF digital audio fiber optic multiplexer with operational features making it unique in the industry. The Multiplexer is ideal for ENG, field, editing and production applications. It is designed to be used with the UTIL-200 modular tray.

FEATURES

The **AES-2200** multiplexer transports up to 8 AES/EBU/SPDIF digital audio channels (up to 16 mono). Up to 6 110 ohm balanced AES3 channels and 2 75 ohm unbalanced AES3 channels can be transported. It can accept sampling rates from 32 to 96 khz. It can also transport up to 2 simplex RS232, RS422 or RS485 data channels. It has audio and optical LED status indicators and dry alarm relay contacts. It is available in all standard wavelengths in both single and multi-mode. CWDM versions are also available, allowing up to 8 multiplexers (for a total of 64 audio streams) to share a single fiber. Optical budget is up to 30db for single mode systems.

OPERATION

AUDIO and DATA TRANSPORT

Connect the audio and data channels as indicated in the Audio Connections Drawing, or use the optional screw terminal adaptor. Note that while the AES-2200 can accept audio streams with sampling rates from 32 to 96 khz, the transmitter sample rate converts these streams to 48khz for transport. **PLEASE NOTE:** The receiver **DOES NOT** convert them back to their original sample rate. Thus, the user must ensure that his facility can handle 48khz operation.

STATUS INDICATORS and ALARMS

The transmitter and receiver each have a green **POWER** LED, and 8 red **ERROR** LED indicators, one for each audio channel, that glow if there is an error condition associated with that channel. The errors could include a missing or corrupt AES/EBU/SPDIF signal, or one that has a sample rate outside the 32 to 96 khz range. The transmitter has a red **LASER FAIL** LED that glows if the laser fails. There is a dry relay contact closure that mirrors the laser fail indicator. On the receiver, there is a red **UNLOCKED** LED that glows upon loss of optical signal. The receiver also has a relay dry contact closure that mirrors this condition.

DATA TRANSPORT SETUP

If the user wishes to transport data, he must set PCB jumpers for the protocol desired.

On the transmitter, the user must, if using RS4xx, set J7 and J8 to terminate the data inputs to 100 ohms. This is not necessary if the data is RS232 or if the transmitter data inputs are connected in parallel with other transmitters, one of which will have the termination instead. When connecting transmitters in parallel, only one can be terminated. To enable the termination, short pins 2 and 3 on J7 and J8; otherwise short pins 1 and 2. Pin 1 is toward the front edge.

On the receiver, the user must, if using RS232, short J3, J4, J7 and J8 pins 1 and 2. Otherwise short pins 2 and 3. Pin 1 is towards the front edge of the PCB.

SPECIFICATIONS

Digital Audio Performance:

Input Level	0.2 to 10 V p-p, 110 ohms
Impedance, ohms	110 balanced, 75 unbalanced
Connector	DB25
Adapter	optional screw terminal
Input Sample rates	32 to 96 khz
Output sample rate.....	48 khz
Output Level	2 -7 V p-p, 110 ohms
Return Loss.....	>15db, 100 khz to 6 mhz
Output Jitter.....	< 20ns

Data:

Baud rate.....	up to 9600
Protocols.....	RS232, 422, or 485

General:

Power dissipation.....	< 2 Watts
AC operation.....	85 to 265 VAC
Operating temperature.....	0 to +50 °C

Specifications subject to change without notice

DRAWINGS

AES-2200-FRX Modular Card Mechanical Drawing

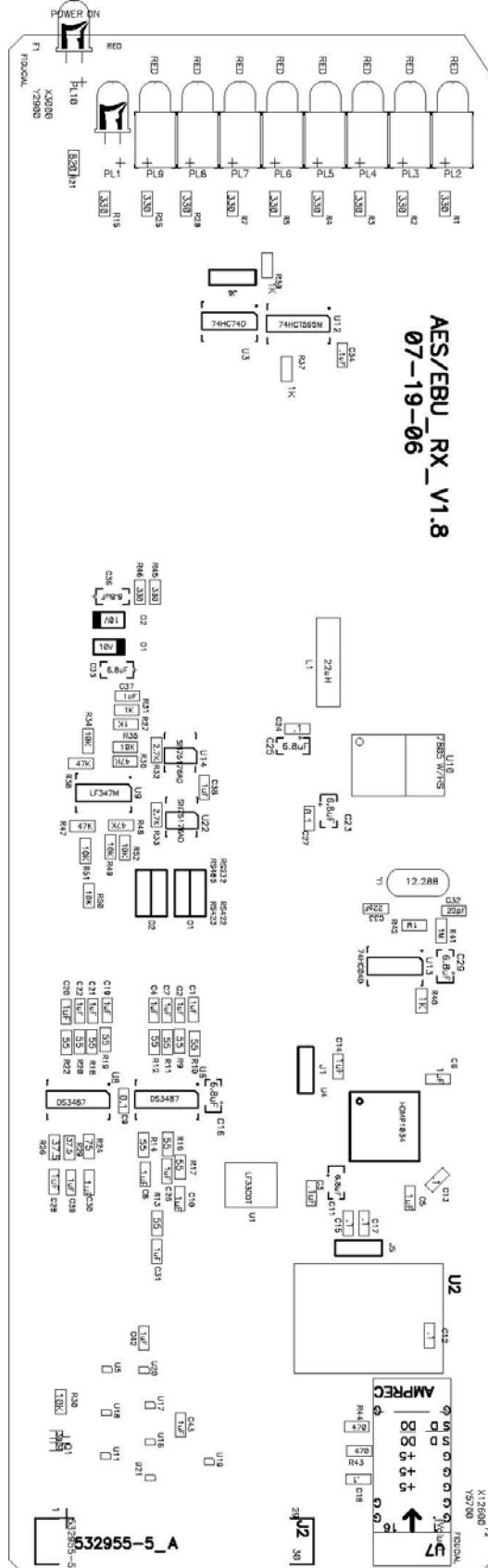

AES-2200 Modular Card Wiring Pinout

AES-2200-FTX Transmitter Wiring:

25 Pin D-Type Connector Inputs	
A1+	11
A1-	23
A2+	10
A2-	22
A3+	9
A3-	21
A4+	8
A4-	20
A5+	7
A5-	19
A6+	6
A6-	18
Data1	3
Data2	5
BNC 75 Ohm Inputs	
A7	J5
A8	J1

AES-2200-FRX Receiver Wiring:

25 Pin D-Type Connector Outputs	
A1+	11
A1-	23
A2+	10
A2-	22
A3+	9
A3-	21
A4+	8
A4-	20
A5+	7
A5-	19
A6+	6
A6-	18
Data1	3
Data2	5
BNC 75 Ohm Outputs	
A7	J5
A8	J1

AES-2000-FTX Stand-alone Mechanical Drawing

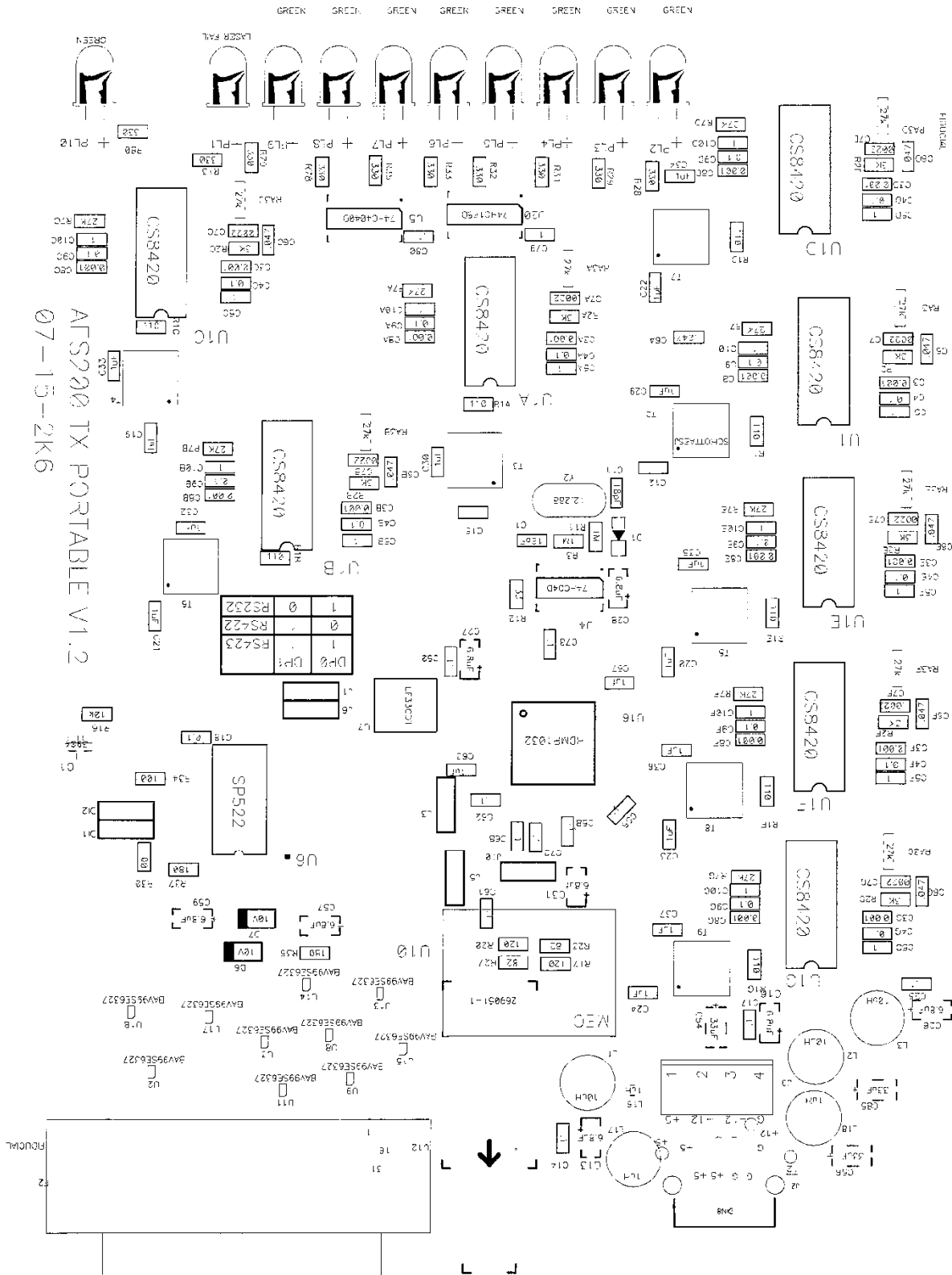

AES-2000-FRX Stand-alone Mechanical Drawing

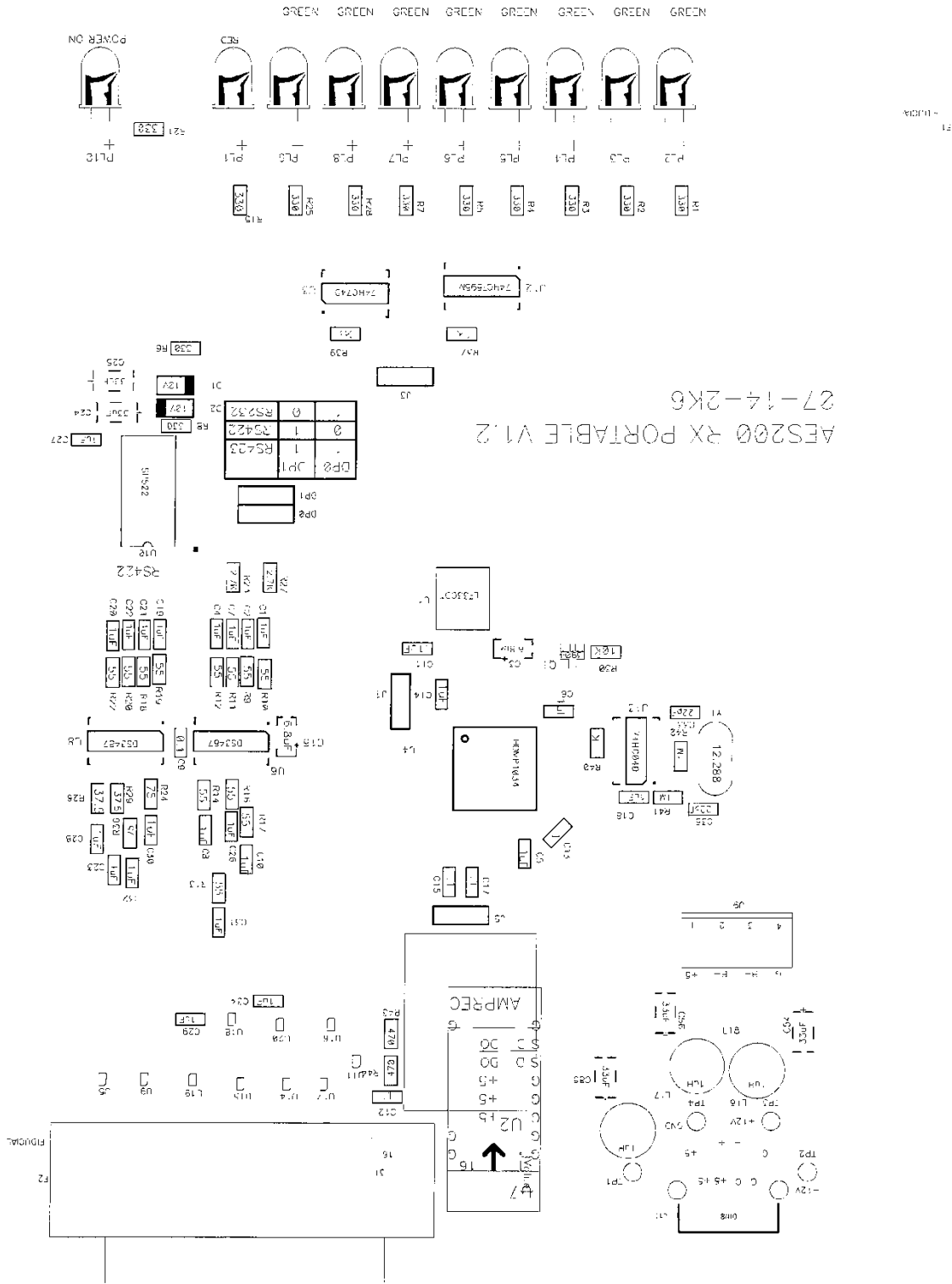

AES-2000 Stand-alone Portable Pinout

REVISED DB25 WIRING

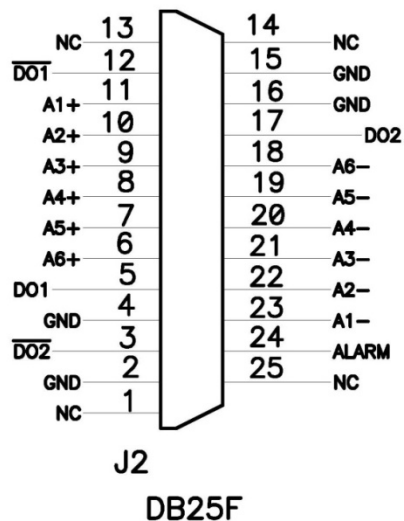
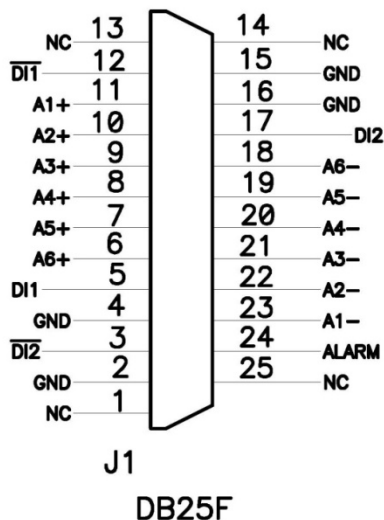

AES2000 TRANSMITTER

AES2000 RECEIVER

A7+ GOES TO J5 CENTER PIN 75 OHM BNC

A7- GOES TO J5 SHIELD 75 OHM BNC

A8+ GOES TO J1 CENTER PIN 75 OHM BNC

A8- GOES TO J1 SHIELD 75 OHM BNC

ALL I/O ARE 110 OHM BALANCED EXCEPT CH7 & 8 WHICH ARE 75 OHM UNBALANCED

RS232: TX: CONNECT BETWEEN $\overline{D1x}$ AND GND

RS232: RX: CONNECT BETWEEN $\overline{D0x}$ AND GND

RS4xx: TX: CONNECT BETWEEN $\overline{D1x}$ AND D1x

RS4xx: RX: CONNECT BETWEEN $\overline{D0x}$ AND D0x

AES-2000 Stand-alone Interface Adapter Pinout

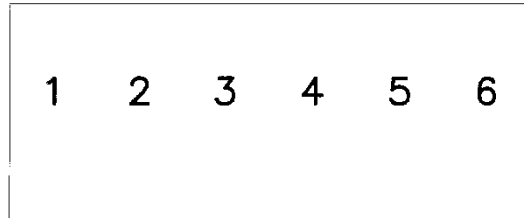

G D1- D1+ G D2- D2+



G A5- A5+ G A6- A6+ G A7- A7+ G A8- A8+

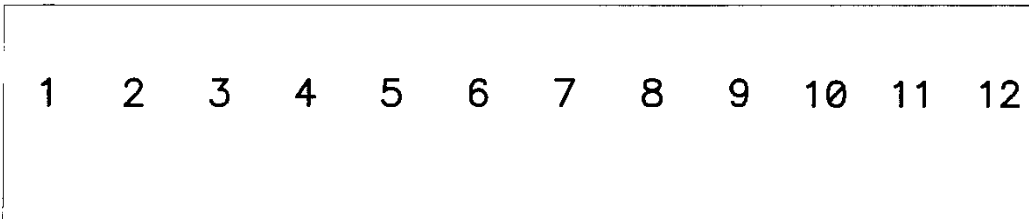

G A1- A1+ G A2- A2+ G A3- A3+ G A4- A4+

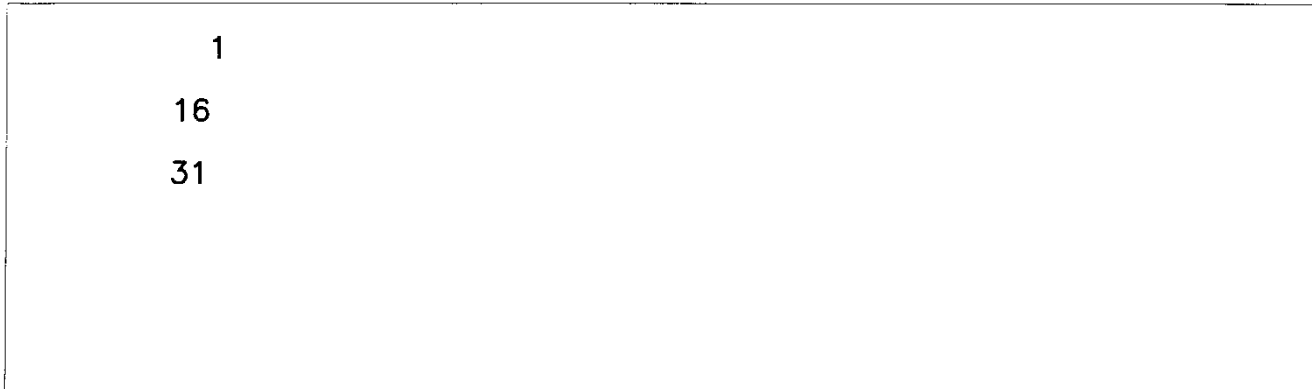

AESMUX_PORT_ADAPTER
07-16-2K6