

Features

- Fully uncompressed up to 1900 x 1200
- Supports :
 - DVI-I - DVI-DL
 - RGB-HV - DVI-D
 - WQXGA, 2560x1600
- Optionally supports:
 - SMPTE 292M 1.5G HD
 - SMPTE 424M 3G HD
- Eq's and re-clocks
- 4.25 Gb/sec bandwidth
- Loop-thru DVI-I input
- Dual DVI-I outputs
- EOS-4000 Supported
- 2 analog audio
- 1 Data (RS232/422/485)
- Non-reduced blanking for CRT & LCD support
- EDID support
- 1 or 2 fiber
- ST or LC - Multimode or Singlemode
- Throw-down or rack

Applications

- Commodity and stock exchanges
- Medical and MRI displays
- Digital signage
- Sporting and concert displays/scoreboards
- Digital cinema
- Air traffic Control
- Military info displays



Supports multiple video formats w/option for conversion to SDI

The DVI-6000 is a long-haul fiber optic transport solution for high-quality RGB-HV and DVI-D with a DVI-I interface. Ideal for keeping video and audio communications secure in Command and Control facilities, the DVI-6000 Single Link supports up to 1920x1200 and the Dual Link up to 2560x1600 resolution over a single fiber, and has optional stereo audio and bi-directional data for monitor control. The DVI-6000 transports a pixel-for-pixel image that is 100% transparent with no frame dropping up to WUXGA, 1920x1200, and enables 100% 24-bits for all scan rates with no contouring or bit reduction at a high scan rate.

The DVI-6000 system is a convenient single-fiber solution. It has been designed to increase the transmission distance limitations of high resolution RGB and DVI video and computer graphics. The system will transport virtually any VESA-compliant DVI or RGB signal from 640x480 VGA up to and including 1920 x1200 @ 60Hz Reduced Blanking WUXGA or, with the dual link option, 2560 x 1600 WQXGA, as well as HDTV formats from 480P up to and including 1080P.

The DVI-6000 also supports HDTV and non-RGB video formats such as YUV, YCrCb or YPrPb. The DVI-6000 has built in reclocking of the DVI signal to eliminate jitter. EDID data can be obtained from a local monitor connected to the loop thru port, a built in PROM, or, from a monitor connected to the receiver.

The DVI-6000 also supports the transport of 2 audio channels (one stereo pair) and unidirectional or bidirectional RS232, 422 or 485 type data. The audio path is intended not only for line-level audio such as might be obtained from a computer sound card, but for professional 600 ohm balanced audio applications as well. No additional fibers are required for the audio or data, although 2 fibers are required for bi-directional data and remote EDID options.

The DVI-6000 supports operation and setup via the front panel switches (hardware mode) or a software GUI (GUI mode). Most functions are automatic and should not require front panel switch setup. Firmware updates may also be applied via the USB port.

If your signal is 1080p, the resulting transport stream is a SMPTE 424M video signal that can be received with an 3G capable optical receiver.

When the signal is not 1080p, the resulting signal is a 3G SMPTE 348M SDTI data stream (3G mode) that will pass through a 3G infrastructure but, since it is not video, is not viewable.

Trust MultiDyne and our 7-year warranty for all of your display and video transport needs.

Designed and manufactured in New York.



* slight compression in single-fiber versions

Easy video display transport with the DVI-6000

Basic Configuration

In its basic form, the DVI-6000 will allow you to remote your computer monitor up to 10km from its source CPU. With the single-fiber version, there is minimal compression of the video signal. In the other versions, there is no compression at all.

There are two analog audio paths (balanced or unbalanced) that can be used for either the line level output of a computer or workstation or for any other analog audio source material. There is also support for uni-directional RS-232, 422 or 485 data. The loop video out connector can be used to simultaneously support a video projector for conference room applications. Finally, EDID is fully supported.

The DVI-6000 packs a lot of functionality into a very small package...and at a great price.

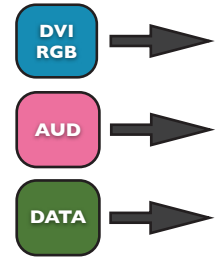

And More...

As an option, you can have bi-directional data and/or conversion of your DVI or RGB video signal into a SMPTE compliant format available as a BNC on the rear of the DVI receiver. In this mode the DVI video signal is packetized into a proprietary format and then transported via a 3G SMPTE envelope or physical layer signal. Instead of fiber transport, there is an optional 75 ohm coax cable transport feature for 3G mode. (Some features not available in cable transport mode).

In addition to the convenience of having your monitor signal converted to 3G video, the resultant video signal can now be patched or routed through any 3GB/sec capable routing switcher.

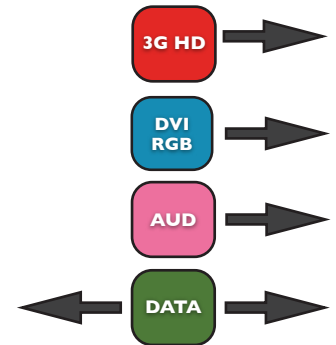

Fully Functional GUI

As if all of this wasn't enough, the DVI-6000 system is fully controllable and monitorable via an elegant GUI interface. After the simple installation procedure you will be able to monitor every aspect of your fiber link as well as perform firmware updates. These functions are accessed via the front panel mini USB connector.

The 6-position DIP switch on the front of each unit provides control for DVI/RGB priority, 3G SMPTE mode, EDID information, audio attenuation and data formats and terminations.

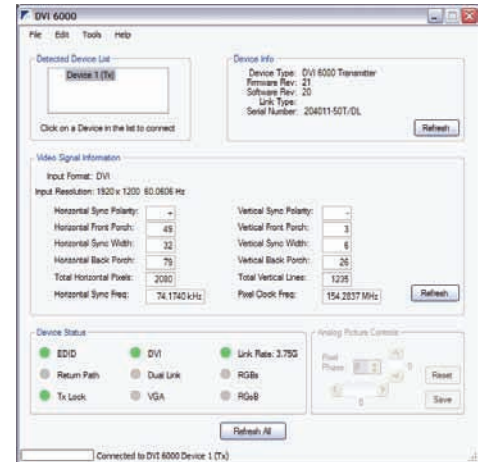

A Note About Video Resolution

In the 1-fiber version, the DVI-6000 will transport completely uncompressed DVI single-link video or a slightly compressed DVI dual-link video signal. In 2-fiber versions, there is no compression in either format. So what does "slightly compressed" actually mean? We use what is called "color space" compression. With this compression scheme, all of the luminance information is preserved without compression but just half of the chrominance information is transported. Since human vision is far less sensitive to the position and motion of color, this 4:2:0 scheme results in the best possible compromise that is indiscernible from uncompressed video in a moving image and allows us to offer a single-fiber solution. The major benefit of a single fiber, single wavelength signal is that it can be easily patched and routed through our EOS line of routers.

Applications

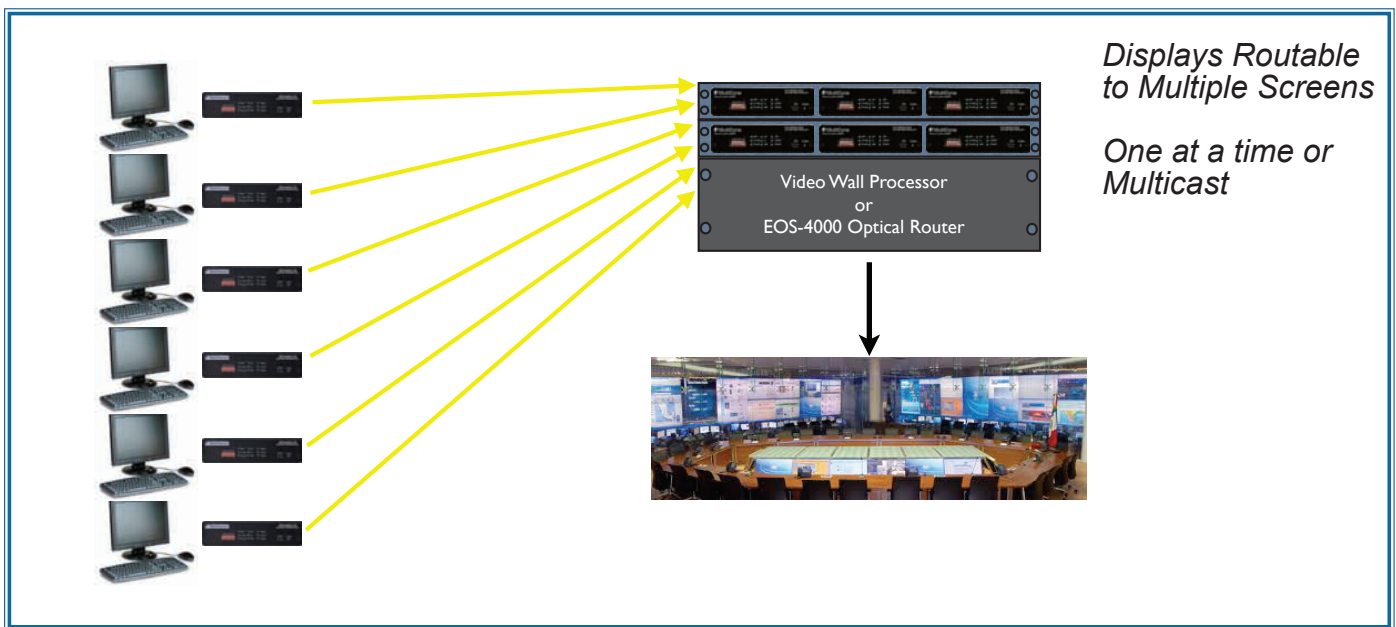
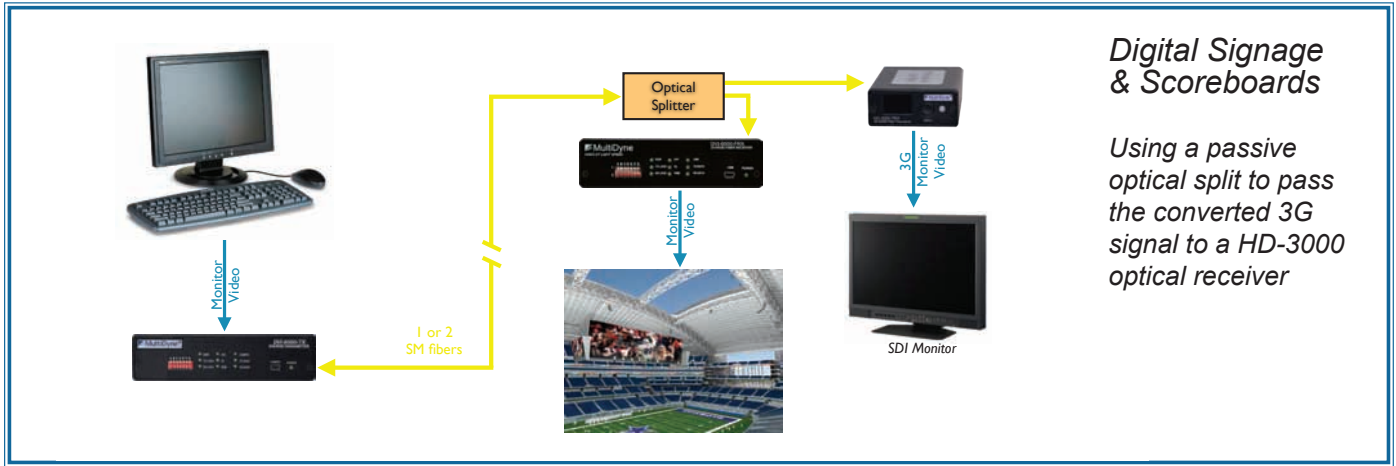

System Block Diagram

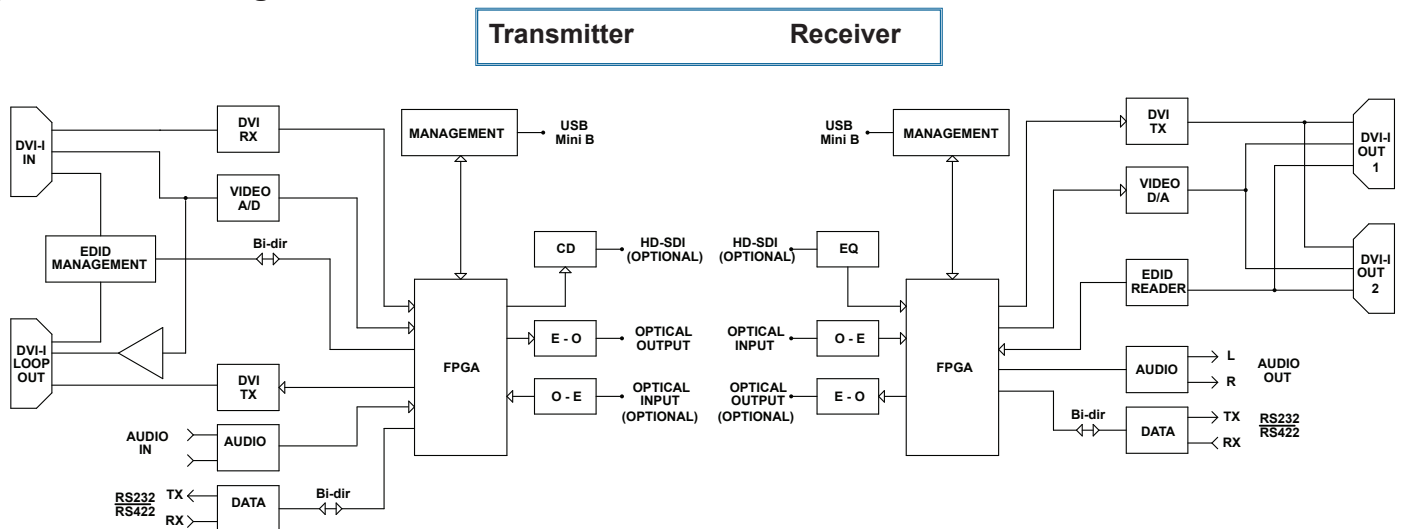

Specifications

Video

DVI connector 1 w/ loop out, Dual outs on RX
 Scan rates As per VESA standards
 Standards DVI and RGB including VGA, SVGA, XGA, WXGA, HDMI (480I, 480P, 720P, 1080I or 1080p) not HDCP encrypted 25-165 MHz
 HDMI via adapter cable
 Resolutions up to 2560x1600 Dual-link or 1920x1200 single-link

Serial Data

232,422,485 DC-3Mbps
 232 In V +/- 25V max, 2V min
 232 Out V +/- 5V @ 3Kohm
 422,485 In V -7V to 12V, 0.2V diff min

Analog Audio

Connectors (unbal) 3.5mm stereo
 Connectors (bal) 9-pin DIN
 S/N >90db
 Frequency Response < +/-0.1db (20Hz - 20kHz)
 Distortion 0.05%
 Max Input level <+4db (bal) <+16db (unbal)
 Max Output level Unity gain
 Impedance In (bal) 600 Ohm
 Impedance In (unbal) >10k Ohms
 Impedance Out (bal) 600 Ohms
 Impedance Out (unbal) <100 Ohms

Operating Distances

multimode up to 150m
 Std. Singlemode up to 4km
 DFB Singlemode up to 10km

Electro-Optical

Operating Wavelengths 850 and 1271-1591nm
 TX Laser output power -2 - 0dBm, Class 1
 Receiver Sensitivity up to -18 dBm
 Fiber Compatibility single or multimode
 Optical Connector ST, LC, SC

Mechanical, Environmental

Dimensions (LxWxH) 6.75" x 5.5" x 1.75"
 Weight 2 lbs.
 Config port Mini-USB
 Temperature Range -0° to +70°C
 Humidity Range 0 to 95% RH
 Noncondensing
 2.5mm jack
 Center pin +
 50w max@14 VDC
 Power Input 15w @9-24VDC
 Power rating, nominal
 Power Requirement

Ordering Information

MULTIMODE	1-way data Connector type = ST, SC or LC
DVI-6000-FTX-2-ST	DVI Single Link & RGB-HV TX, WUXGA, 1920 x 1200, with 2-Ch Audio & RS-232 Data, One Fiber, Multimode
DVI-6000-FRX-2-ST	DVI Single Link & RGB-HV RX, WUXGA, 1920 x 1200, with 2-Ch Audio & RS-232 Data, One Fiber, Multimode
SINGLEMODE	1-way data Connector type = ST, SC or LC
DVI-6000-FTX-50-ST	DVI Single Link & RGB-HV TX, WUXGA, 1920 x 1200, with 2-Ch Audio & RS-232 Data, One Fiber, Singlemode
DVI-6000-FTX-7-xxxx-ST	DVI Single Link & RGB-HV TX, CWDM wavelengths, WUXGA, 1920 x 1200, with 2-Ch Audio & RS-232 Data, One Fiber, Singlemode
DVI-6000-FRX-50-ST	DVI Single Link & RGB-HV Receiver, WUXGA, 1920 x 1200, with 2-Ch Audio & RS-232 Data, One Fiber, Single-mode
SINGLEMODE	2-way data Connector type = ST, SC or LC
DVI-6001-FTX-50-ST	DVI Single Link & RGB-HV TX w/ Two-way data, WUXGA, 1920 x 1200, with 2-Ch Audio, One Fiber, Single-mode
DVI-6001-FRX-50-ST	DVI Single Link & RGB-HV RX w/ Two-way data, WUXGA, 1920 x 1200, One Fiber, Single-mode with 2-Ch Audio, One Fiber, Singlemode
DVI-6002-FTX-50-LC	DVI Single Link & RGB-HV TX w/ Two-way data, WUXGA, 1920 x 1200, with 2-Ch Audio, LC connectors, Two Fibers, Singlemode
DVI-6002-FRX-50-LC	DVI Single Link & RGB-HV RX w/ Two-way data, WUXGA, 1920 x 1200, with 2-Ch Audio, LC connectors, Two Fibers, Singlemode
OPTIONAL	
-SDI	Add SDI conversion/transport to ANY of the above
ACCESSORIES	
DVI-6000-PS	Replacement Power Supply for KVM-6000 units
TRI-PS-5DC	Three Output DC Power Supply for up to three DVI-6000 modules
RMT	Triple Rack-mount Kit (1 kit)
BP-T	Blank panel for RMT rack-mounting kit
DIN-BO	DIN connector breakout for data and balanced audio
DVI-HDMI	HDMI adapter cable



Tri-PS Power Supply

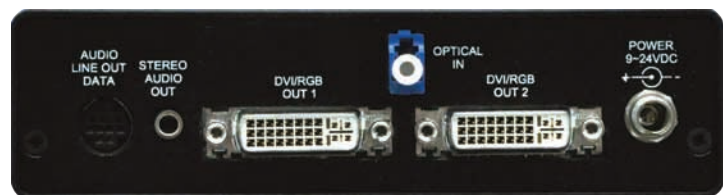

Receiver Rear Panel



191 Forest Avenue
 Locust Valley, NY 11560
 Phone 516-671-7278
 Fax 516-671-3362

Transmit • Route • Receive

www.multidyne.com

